

OWNER'S MANUAL

- Parts List
- Assembly and Operating Instructions
- Recipes
- Accessories
- Warnings (Page 10)

Wrangler #2123



The BIG Grill in the Little Box!



• Non Stick • Cleans Easily
• Non Warp • Enhances Flavor

CAST IRON GRATES

EASY DUMP ASH PAN
Easy Clean Up

ADJUSTABLE GRATE

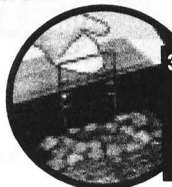

3 Positions:
High
Medium
Low

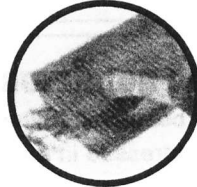

www.chargriller.com

BUYERS GUIDE

<input checked="" type="checkbox"/>	LIFTABLE GRATES	— ADD COALS AS YOU COOK
<input checked="" type="checkbox"/>	SHELVES	— CONVENIENT
<input checked="" type="checkbox"/>	EASY DUMP ASH PAN	— EASY CLEAN UP
<input checked="" type="checkbox"/>	ROTISSERIE ADAPTABLE	— VERSATILITY
<input checked="" type="checkbox"/>	HEAT GAUGE	— TIMING
<input checked="" type="checkbox"/>	DOUBLE BOTTOM	— STOPS BURN OUT
<input checked="" type="checkbox"/>	ADJUSTABLE GRATE	— BETTER HEAT CONTROL
<input checked="" type="checkbox"/>	ADJUSTABLE DAMPERS	
<input checked="" type="checkbox"/>	638 GRILL AREA	— SERVE MORE PEOPLE
<input checked="" type="checkbox"/>	SIDE BOX ADAPTABLE	— ANOTHER WAY TO SMOKE
<input checked="" type="checkbox"/>	POWDER COAT FINISH	— DURABLE
<input checked="" type="checkbox"/>	CAST IRON GRATES	— EVEN HEAT

PARTS LIST AND TOOLS REQUIRED

(Tools Not Included)

Pliers  and 7/16" nut driver 

HARDWARE USED WITH YOUR CHAR-GRILLER

Note: Hardware bag may contain extras.

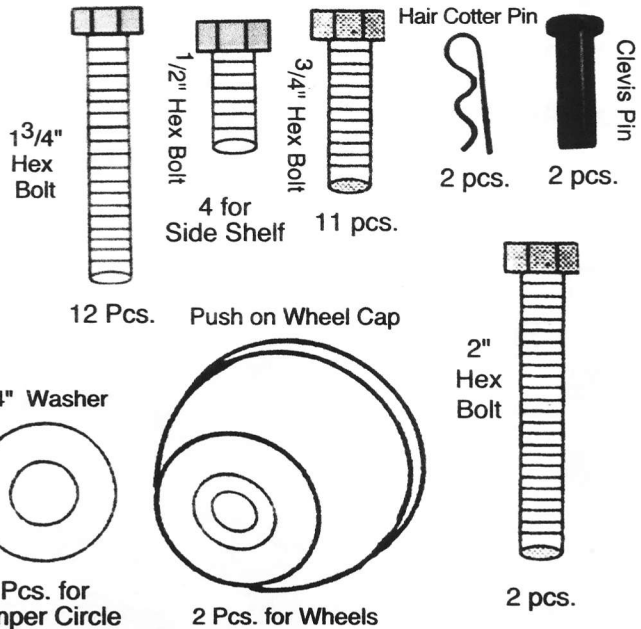

PARTS.....	DESCRIPTION
1.....	EASY DUMP FIRE GRATE
1.....	COOKING GRATES
1.....	GRILL BODY
1.....	HEAT GAUGE
2.....	CLEVIS PINS
2.....	HAIR COTTER PINS
1.....	WOOD FRONT HANDLE
2.....	3/4" HEX BOLTS
2.....	LOCK WASHERS
2.....	1/4" HEX NUTS
1.....	SMOKESTACK
2.....	3/4" HEX BOLTS
2.....	1/4" HEX NUTS
2.....	LEGS (SHORT)
2.....	LEGS (LONG)
4.....	1 3/4" HEX BOLTS
4.....	1/4" HEX NUTS

PARTS.....	DESCRIPTION
2.....	WHEELS
1.....	AXLE
1.....	PUSH ON WHEEL CAPS
1.....	FRONT SHELF ASSEMBLY
2.....	10" FRONT SHELF SUPPORTS
4.....	3/4" HEX BOLTS & NUTS
2.....	HANGERS (FOR FIRE GRATE)
2.....	LEG BRACES
8.....	1 3/4" HEX BOLTS & NUTS
1.....	SIDE SHELF ASSEMBLY
4.....	1/2" HEX BOLTS
4.....	1/4" HEX NUTS

PARTS.....	DESCRIPTION
1.....	WARMING RACK
2.....	2" HEX BOLTS
2.....	3/4" HEX BOLTS
4.....	1/4" HEX NUTS
1.....	DAMPER CIRCLE
1.....	3/4" HEX BOLT
2.....	1/4" FLAT WASHER
1.....	LOCK WASHER
1.....	1/4" HEX NUT

NO RETURNS ON USED GRILLS

STOP! CALL  FIRST! DO NOT RETURN PRODUCT TO STORE.
CALL (912) 638-4724 This product has been built to the highest quality standards.
 Call us should you have any questions not addressed in these instructions, or for service information.



ASSEMBLY INSTRUCTIONS

Read all safety warnings and instructions carefully before assembling and operating your grill.
IMPORTANT HINT: DO NOT TIGHTEN ANY NUTS AND BOLTS UNTIL GRILL IS FULLY ASSEMBLED.

(Estimated Assembly Time: 45minutes)

1. Assembly requires 2 people. Get another person to Help. For easiest assembly use a **HAMMER**, **PLIERS** and a **7/16" NUT DRIVER**. **NOTE: Do Not tighten any bolts unless instructed to do so. Tightening too soon may prohibit parts from fitting together. All Hex Nuts should be on the Inside of the grill unless stated otherwise.** Unpack all contents in a well-cleared and padded area.
2. Insert one **LONG LEG** into one **SHORT LEG**. See **Fig. A**. Repeat this step for the other **LONG** and **SHORT LEG**.
3. Attach **LEG BRACES** to the outside of one of the **LONG** and **SHORT LEG** assemblies you just made. See **Fig. B**. Use two 1 3/4" hex bolts and nuts for each **LEG BRACE** but only finger tight.
4. Insert all four corners of the **BOTTOM WIRE SHELF** into the four holes located near the bottom inside of the four **LEGS**. See **Fig. C**. Next, rotate the **LEGS** upward until vertical. Important: Make sure the two Long Legs are on the same end.
5. Attach the other end of the **LEG BRACES** to the corresponding legs using 1 3/4" Hex Bolts and Nuts but only finger tight. See **Fig. D**.
6. Gently hammer one **HUB CAP** to one end of the **AXLE**. Slide one **WHEEL** onto the **AXLE**. Insert **AXLE** through the holes at the bottom of both **SHORT LEGS**. Slide second **WHEEL** onto **AXLE** then gently hammer the second **HUB CAP** onto **AXLE**. Next insert a cotter pin through the hole in each end of the axle and spread the tip of the cotter pin. See **Fig. D**.
7. Stand the **CART/LEG ASSEMBLY** upright. Attach the bottom half of the **BODY** to the **CART/LEG ASSEMBLY** (make sure damper is on same side as wheels) with four 1 3/4" Hex Bolts. There are two holes in the front and two in the back of the grill **BODY**. See **Fig. E**.

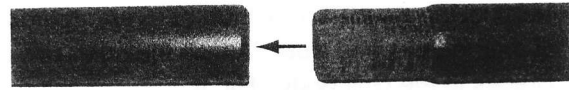

SHORT LEG

FIG. A

LONG LEG

FIG. B

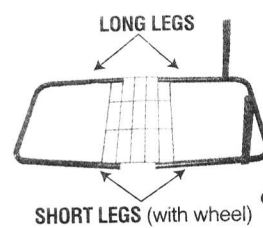

FIG. C

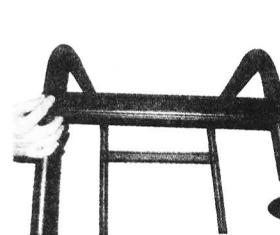
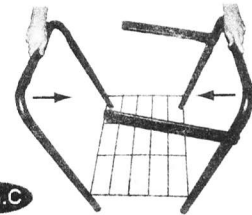

FIG. D

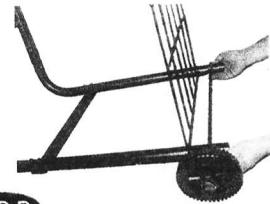
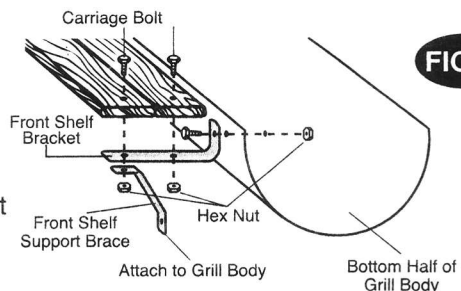

FIG. E



Damper

8. Attach two (2) 8" **FRONT SHELF BRACKETS** to the front edge of **BOTTOM HALF** of grill body using two (2) 3/4" Hex Bolts and Nuts (with the nuts on the inside of the grill). Attach the long **WOOD SLATS** to the **FRONT SHELF BRACKETS** and at the same time attach the **FRONT SHELF SUPPORT BRACES** to the underside of the outer **Holes** of the **FRONT SHELF BRACKETS** with four (4) 1" Carriage Bolts and Nuts. Attach the other end of the Support Braces to the Grill Body. **Fig. G.**



9. Insert **SMOKESTACK** from **INSIDE** the **HOOD** up through the hole. Attach with two (2) 3/4" hex bolts with the nuts on the inside. **Fig. H.** Note: It is not necessary to remove the Stack Damper.

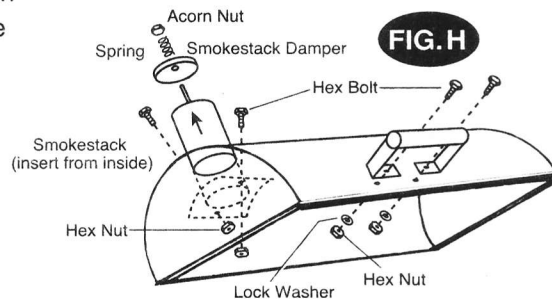

10. Insert **HEAT GAUGE** through hole in hood (from outside) and push the **SPLIT RING** over tabs on the side of **HEAT GAUGE** from inside the hood.

11. Attach **WOOD HOOD HANDLE** to the center of the **HOOD** with two (2) 3/4" hex bolts, lock washers, and hex nuts. **Fig. H.**

12. Set the **HOOD**, in the **CLOSED POSITION**, on top of the bottom Half of the grill body. Line up the Hinge holes and insert the Clevis Pins. This may require lifting up on the back of the Hood. Then, carefully open the hood, making sure to not let the Clevis Pins fall out, and insert the Hair Cotter Pins into the Clevis Pins. **Fig. I.**

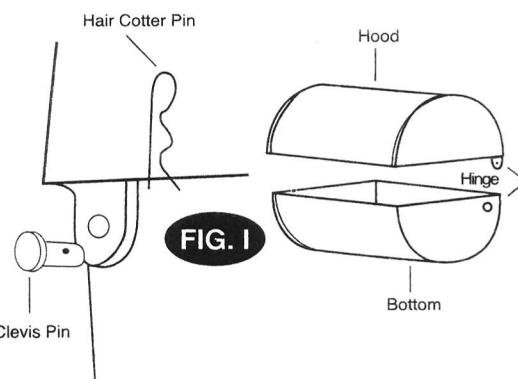

13. Attach the **DAMPER CIRCLE** to inside of bottom half of grill body with a 3/4" Bolt. The bolt goes thru a Flat Washer, thru the Damper Circle, thru the Grill Body, thru another Flat Washer, thru a Lock Washer, and finally attached to a Hex Nut. The small tab on the Damper Circle should protrude outward. **Fig. J.**

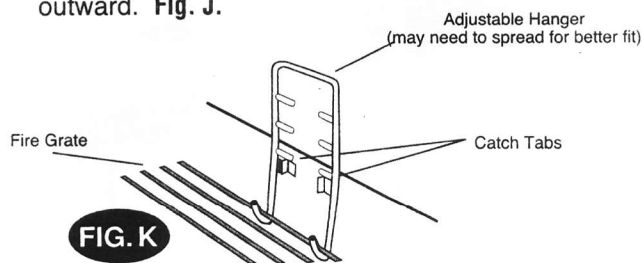
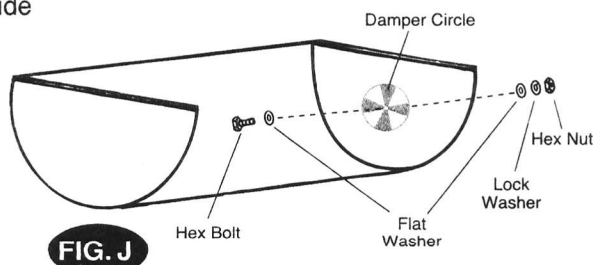

14. Attach **SIDE SHELF** to the four (4) holes on left side of grill with 1/2" hex bolts and nuts. **Fig. L.**

15. **ATTACHING WARMING RACKS PIVOT BOLTS:** On each **END** of the **HOOD** just back of center, insert one (1) 2" **HEX BOLT** (total 2) (from outside in) in holes (A) with **HEX NUTS** on inside of **HOOD**. **Fig. M.**

On each **END** of the **LOWER GRILL BODY** 4" from the back corner, insert one (1) 3/4" **HEX BOLT** (total 2) (from outside in) in holes (B) with **HEX NUTS** on inside of **GRILL BODY**. **Fig. M.**

Do not install **WARMING RACK** until after tightening all four **WARMING RACK PIVOT BOLTS**.

ATTACH THE WARMING RACK'S (4) WIRE LOOP HOLES, located on the **WARMING RACK'S SIDES** and **WIRE LEGS**, over the four (4) **PIVOT BOLTS** in the **HOOD** and **GRILL BODY**. Attach left side first. **Hint:** You may flex the **WIRE LEG** outwards for a tighter fit and to center. **Fig. M.**

16. Tighten **ALL** nuts and bolts.

17. Place **FIRE GRATE**, with **ADJUSTABLE HANGERS** attached, into **BOTTOM HALF** of grill body. **Fig. K & L.** Install the **COOKING GRATES**.

CONGRATULATIONS, ASSEMBLY COMPLETE!

Hint: The paper label that is affixed to the hood is more easily removed when the hood is warm. Any remaining glue residue can be cleaned off with a spray lubricant like WD-40.

Please Note, No Returns on Used Grills.

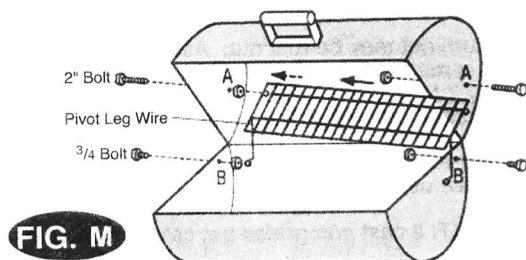
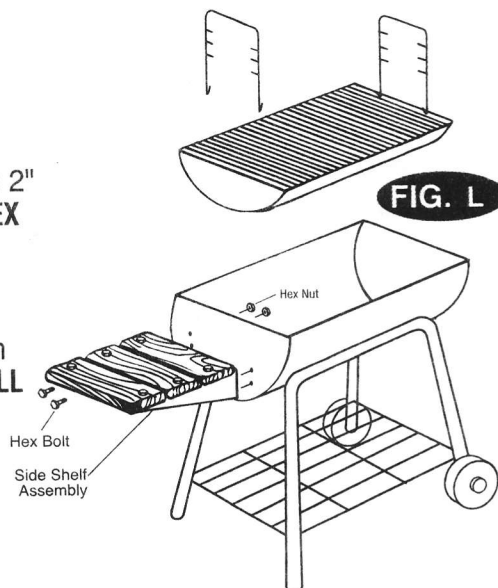

GRILL PREPARATION & OPERATING INSTRUCTIONS

PLEASE NOTE: NO RETURNS ON USED GRILLS



Read all safety warnings and instructions carefully
Before assembling and operating your grill.

1. Cure GRILL prior to your initial use to protect the interior and exterior finish and to prevent unnatural flavors to your first meals. (A) Lightly coat ALL INTERIOR SURFACES (including GRILLS, GRATES, AND INSIDE OF BARREL.) with vegetable oil (spray vegetable oil is easiest but do not use near hot coals or fire). (B) Build a medium sized fire on the fire grate. (C) After coals ash over, spread out coals, replace cooking grates, close lid and heat at approximately 250 F for two hours. Re-coat GRATES and return to grill at approximately 200 F for two hours. You can **lightly** coat the exterior of the grill body (while warm) with vegetable oil. This will extend the life of the finish, much like waxing a car. Your GRILL will then be ready for use. NOTE: Grill will drip a lot of oil during this process and for several uses but will slow over time.

NEVER EXCEED 400 BECAUSE THIS WILL DAMAGE THE FINISH AND CONTRIBUTE TO RUST. PAINT IS NOT WARRANTED AND WILL REQUIRE TOUCH-UP. THIS UNIT IS NOT WARRANTED AGAINST RUST.

2. To START FIRE – stack 50-60 briquets in pyramid and saturate with lighter fluid (DON'T USE GASOLINE). Light coals in several places, close lid after briquets ash over or gray, spread them out and start cooking. If one end burns faster, use tongs to move coals from one end to the other for even heat. **ALWAYS FOLLOW CHARCOAL AND LIGHTER**



FLUID MANUFACTURERS' INSTRUCTIONS AND WARNINGS. USE OUTDOORS ONLY ON NONCOMBUSTIBLE SURFACE – 15' AWAY FROM WOOD AND COMBUSTIBLE MATERIAL.

3. Control heat with amount and type of FUEL, DUAL DAMPERS and ADJUSTABLE FIRE GRATE. Adjust GRATE one end at a time. Wood burns hotter than coals. More airflow is more heat.

4. For no flare-ups, cook with lid in the down position. Add water soaked hardwood chips for a smoked flavor.

5. Suggestion: Screw 3/4" cup hooks (not furnished) on front of the wood shelf to hang cooking utensils.

6. Burn out may be rust out. Ashes left in bottom too long hold moisture and rust through any thickness of steel. This grill is made of steel and cast iron, which **WILL RUST, ESPECIALLY IF NOT PROPERLY CARED FOR.**

7. Do not use self-strting charcoal as it will give unnatural flavor. Burn lighter fluid completely before closing lid.

8. After using, coat vegetable oil on interior grates and bare metal while warm to reduce rust. On the EXTERIOR, remove rust with wire brush and touch up with a high heat paint, available at most hardware/auto stores.

9. HINT: If cast iron grates get caked, put them in self cleaning oven. They come out like new, but need re-seasoning.

10. You may place a coffee can on bottom shelf under the hole in the grill to catch drippings.

11. HEAT GAUGE may obtain moisture, which will steam out during cooking. Gauge may be calibrated in oven.

12. You may fill unwanted holes with Nuts & Bolts (Not Provided).

NOTE: Smoke will escape from areas other than the smokestack. This should not affect your cooking.

GRILLING RECIPES

DIRECT METHOD

STEAK (& ALL MEATS): Cook food directly above coals. Generally speaking, to grill meats, raise fire grate to high position (hot) and sear for one minute on each side with the lid open to seal in flavor and juices. Then lower fire grate to medium position with lid closed and cook to desire doneness. Control heat with dual dampers and adjustable fire grate.

BETTER BARBECUE: Place grilled meat back in the marinade for several minutes before serving – it will become tastier and juicier. CAUTION: Boil extra marinade first to kill bacteria remaining from the raw meat.

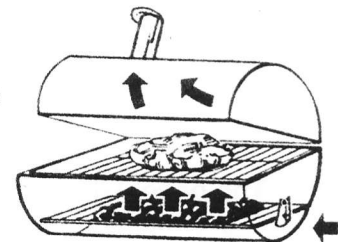

Cooking with a MEAT THERMOMETER ensures food is fully cooked. Insert into thickest part not touching bone & allow five minutes to register. Internal temperatures for BIRDS should be 170 to 180 and meat should be 140 for rare, 160 medium and 170 for well done.

GRILLING RECIPES (continued)

MARINATED FLANK STEAK – Mix marinade ingredients in nonmetal dish. Let steak stand in marinade for no less than 4 hours in refrigerator. Brown each side for 5 minutes, but center should remain rare. Cut steak diagonally across the grain into thin slices before serving. Grill with fire grate in high (hot) position with lid open or closed.

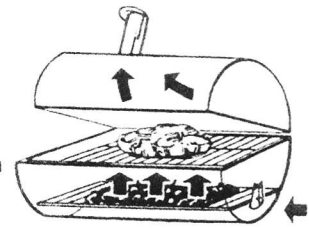

MARINADE: 1/2 cup vegetable or olive oil, 1/3 cup soy sauce, 1/4 cup red wine vinegar, 2 tbs. Lemon juice, 1 tsp. Dry mustard, 1 minced clove garlic, 1 small minced onion, 1/4 tsp pepper.

QUAIL OR DOVES – Cover birds in Italian dressing (Good Seasons or Kraft Zesty), marinate overnight, pour off dressing and cover with Texas Pete Hot Sauce for 6 hours. Wrap birds in thick bacon secured by a toothpick. *Place on grill – keep turning until bacon is black. Grill for 20 minutes. Sear with lid open and fire grate in high (hot) position for 1 min each side before lowering grate and closing lid. *OR SMOKE by placing birds in center of GRID with fire in both ends of FIRE BOX.

KABOBS – Alternating on skewers any combination of meat, onions, tomatoes, green peppers, mushrooms, zucchini, circular slice of corn-on-the-cob, or pineapple. Meat could consist of chunks of shrimp, scallops, lobster, chicken, sausage, pork, beef, etc. Marinate the meat in refrigerator for several hours. Grill each side approximately 7 minutes turning occasionally while basting with marinade. Leave a small amount of room between pieces in order to cook faster. Grill with lid up and the fire grate in the lowest position. See marinade recipe on last page.



KABOB MARINADE: Mix 1 cup soy sauce, 1/2 cup brown sugar, 1/2 cup vinegar, 1/2 cup pineapple juice, 2 teaspoons salt, 1/2 teaspoon garlic powder and bring to a boil. Marinate beef in mixture a minimum of 4 hours.

HOT DOGS – Grill with lid up and fire grate in high (hot) position for approximately 6 minutes, turn every few minutes.



HAMBURGERS – Mix in chopped onions, green peppers, salt, sear 3/4 inch patties on each side with fire grate in high position for a few minutes. Lower fire grate to medium position and grill with lid down to avoid flare-ups. Cook each side 3 to 7 minutes according to desired doneness. Cook ground meat to 150 internally or until juice runs clear (free of blood) for prevention of E.coli.

Burgers can be basted with marinade when turning and/or other ingredients can be mixed in with the ground beef such as chili sauce or powder; or you may marinate by allowing to stand in marinade for 1 or 2 hours at room temperature before cooking; or let stand in covered dish in refrigerator up to 24 hours. Bring to room temperature before cooking. See meat marinade on page 9.



SHRIMP (Peeled) & Crayfish – Place on skewers, coat with melted butter and garlic salt. Grill 4 minutes on each side or until pink. Cocktail sauce optional.

BAKED POTATOES – Rub with butter and wrap in foil and cook on grill with lid down for 50 minutes. Turn after 25 minutes (no need to turn if smoked). Squeeze for doneness.

SWEET CORN IN HUSKS – Trim excess silk from end and soak in cold salted water 1 hour before grilling. Grill 25 minutes – turning several times.

SWEET CORN IN FOIL – Husk and wash. Rub with butter and season with salt and pepper. Wrap each ear in foil and grill for 30 minutes turning several times (no need to turn if smoked).



GRILLED VEGETABLES – Slice .1/4" thick and soak in olive oil prior to grilling to prevent burning. Grill for 9 minutes each side.



SMOKIN' RECIPES (WATER PAN)

INDIRECT METHOD

Pan not included. Disposable bread pan is recommended

SMOKE BY COOKING SLOWLY (See chart on page 10 for smoking times)

1) Place water/drip pan on left side of fire grate. 2) Place hot coals on right side (damper end) of fire grate. The charcoal basket accessory helps confine coals to one side. 3) Place meat above water pan. 4) Place fire grate in low position. 5) Close lid & control heat with dampers & adjustable grate.

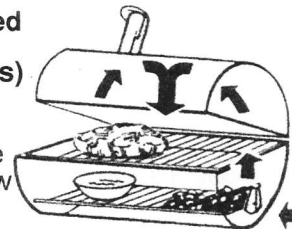

You may want to sear certain foods before smoking by placing meat directly above coals with LID open and FIRE GRATE in high (hot) position for several minutes.

Add flavor soaked wood chips to the fire and add 1 part marinade, beer or wine to 3 parts water to the drip pan.

OPENING THE SMOKING CHAMBER WILL EXTEND COOKING TIME.

Cooking with meat thermometer ensures food is fully cooked. Insert thermometer into thickest part not touching bone, and allow five minutes to register. Internal temperature for birds should be 170° to 180° or when leg moves easily in joint. Meat should be cooked to internal temperature of 140° for rare, 160° for medium and 170° for well done.

ADDING MORE WATER – Check the water level when cooking more than 4 hours or when you can't hear the water simmering. Add water by moving meat over and pouring water through GRILL into WATER PAN.

IF THE SMOKE IS WHITE, THE FIRE'S RIGHT. IF THE SMOKE IS BLACK, ADD SOME DRAFT

SMOKED TURKEY – Empty cavity rinse and pat dry under the back and tie legs together. Place in center foil drip pan of water. Smoke for 12 minutes per minutes per pound if stuffed to allow for expansion. Best results (190° internal).

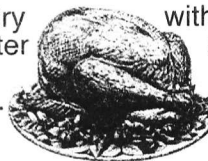

with paper towel, tuck wing tips of cooking grid directly above pound. Allow several extra Use a meat thermometer for

SMOKED BAKED HAM – Fully cooked canned ham or smoked and cured whole ham or shank or butt portion.

Place fire grate in the lowest position and a drip pan under the meat. Remove rind and score fat diagonally to give a diamond effect. Insert a whole clove in to the center of every diamond. Place ham with fat side up in center of cooking grid directly above drip pan. Close lid. About 9 minutes per pound is suggested for fully cooked hams. Smoked or cured ham which is not fully cooked should be cooked to an internal temperature of 160°. Baste with ham glaze 3 or 4 times during last 30 minutes of cooking time. Garnish with pineapple rings about 15 minutes before end of cooking time.



HAM GLAZE: 1 cup of light brown sugar, firmly packed, 1/2 cup orange juice, 1/2 cup honey, combine sugar, juice and honey. Let marinade sit for at least 4 hours.

SMOKED HOT DOGS STUFFED – Slit hot dogs lengthwise, within 1/4 inch of each end. Stuff hot dogs with cheese and relish and wrap in bacon. Place on cooking grid over drip pan and smoke 15-20 minutes or until bacon is crisp.

SMOKIN' RECIPES (WATER PAN)

Indirect Method (continued)

SMOKED CHICKEN PARTS AND HALVES – Rinse pieces in cold water and pat dry with paper towels. Brush each piece with vegetable oil and season to taste with salt and pepper. Brown pieces directly above coals with lid open and grate in high or medium position for several minutes. Then place pieces on cooking grate directly above drip pan. With the grate in the low position, cook with lid down for 55 to 60 minutes or until done. Do not use vegetable oil or salt and pepper if using marinade.

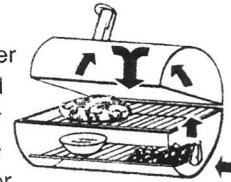

SMOKED VENISON: Place leg of venison in a container or "hefty bag" and marinate for 2-4 days, turning daily. Marinate bacon overnight in its marinade. Remove roast from refrigerator at least an hour before cooking. Season generously with seasoned salt and coarse ground black pepper. Wrap 1 lb. Bacon over the top of the roast, and smoke 20/25 minutes per pound, or until tender. Do not overcook.

Venison Marinade: 1 cup Balsamic or wine vinegar, 1 cup olive oil, 2 oz. Worcestershire, 1/2 oz. Tabasco, 2 tbs. Season All, 1 to 2 chopped jalapenos, 3 oz. Soy sauce. Bacon Marinade: 2 ox. Wine vinegar, 2 oz. Worcestershire, 4 dashes Tabasco.

SMOKED SHRIMP & CRAYFISH: Mix in a foil pan 1/2 cup butter, two cloves of crushed garlic, Tabasco, sliced green pepper, 1 tbs each of minced onions, salt and juices from one lemon. Add shrimp and/ or crayfish and smoke 45 minutes.

SMOKED VEGETABLES: Turnips, potatoes, carrots, okra, mushrooms, peeled onions, zucchini, squash, etc. Put in pan and cover with water and cook for several hours while cooking the meat. Or place vegetables on grill and smoke for 50 minutes, either wrapped in foil or not.

SMOKED FISH: Marinate in brine (1/4 cup dissolved in 1 qt of water) or marinate fish in 1 cup white wine, 1 cup soy sauce mixed with 1 cup lemon juice. Marinate overnight in covered dish in refrigerator. Let air on rack 20 minutes before placing on Pam sprayed grill. Smoke 25 minutes.

SMOKED SPARE/BACK RIBS: Peel off tough layer of skin on back side. Rub all surfaces with seasoning. Place ribs in center of grid above drip pan and smoke approximately 1 1/2 hours or until meats pulls away from bone. Baste with barbecue sauce during last 30 minutes.

CHICKEN MARINADE: Combine 1/2 cup soy sauce, 1/4 cup vegetable oil, 1/4 cup red wine vinegar, 1 teaspoon oregano, 1/2 teaspoon sweet basil, 1/2 teaspoon garlic powder with parsley, 1/4 teaspoon pepper. Pour over chicken pieces in nonmetal dish. Cover and refrigerate overnight, turning occasionally. Use marinade to baste chicken while cooking.

MEAT MARINADE: For steaks, chops, and burgers: Combine 1 cup soy sauce, 2 coarsely chopped large onions and 2 cloves garlic (halved) in an electric blender; cover, process at high speed 1 minute or until mixture is very smooth. Stir in 1/4 cup bottle gravy coloring (Kitchen Bouquet and Gravy Master) and 2 teaspoons Beau Monde seasoning (or substitute 1 teaspoon MSG and 1 teaspoon seasoned salt).

Allow meat to stand in marinade at room temperature for 2 hours or refrigerate up to 24 hours in a covered dish. Bring meat to room temperature before cooking.

SHISH KABOB MARINADE: Mix 1 cup soy sauce, 1/2 cup brown sugar, 1/2 cup vinegar, 1/2 cup pineapple juice, 2 teaspoons salt, 1/2 teaspoon garlic powder and bring to a boil. Marinate beef in mixture a minimum of 4 hours.

SMOKING TIMES



Food	Weight	Water Pan Smokin'	Side Fire Box	Temperature on Meat Thermometer
Beef Roasts, Beef Brisket	3 – 4 lbs.	1 – 1 1/2 hours	4 – 5 hours	140° rare
Lamb Roasts, Venison	5 – 7 lbs.	13/4 – 2 1/2 hours	5 – 6 hours	160° medium
Large cuts of Game	7 – 9 lbs.	2 1/2 – 3 1/2 hours	7 – 10 hours	170° well done
Pork Roasts	3 – 4 lbs.	1 3/4 – 2 1/2 hours	5 – 6 hours	170°
	5 – 8 lbs.	2 1/2 – 3 hours	7 – 8 hours	170°
Pork/ Beef Ribs	Full grill	1 1/2 – 2 hours	4 – 6 hours	Meat pulls from bone
Pork Chops	Full grill	3/4 – 1 1/4 hour	4 – 6 hours	Meat pulls from bone
Sausage Links	Full grill	2 – 2 3/4 hours	4 – 5 hours	170° for fresh sausage
Ham, Fresh	10 lbs.	3 – 4 hours	7 – 8 hours	170°
Ham, Cooked	All sizes	1 1/2 – 2 hours	3 – 4 hours	130°
Chicken (Cut up or split)	1-4 fryers, cut up or split	1 – 1 1/4 hours	4 – 5 hours	180° / leg moves easily in joint
Chicken (Whole)	1-4 fryers	1 1/4 – 1 1/2 hour	5 – 6 hours	180° / leg moves easily in joint
Turkey (Unstuffed)	8 – 12 lbs.	1 3/4 – 2 1/2 hours	7 – 8 hours	180° / leg moves easily in joint
Fish, small whole	Full grill	1/2 – 3/4 hours	2 – 3 hours	Flakes with fork
Fish, filets, steak	Full grill	1/4 – 1/2 hours	1 – 3 hours	Flakes with fork
Duck	3 – 5 lbs.	1 – 1 3/4 hours	5 – 6 hours	180° / leg moves easily in joint
Small game birds	Full grill	3/4 – 1 hour	4 – 5 hours	180° / leg moves easily in joint

**If you purchased the "Side Fire Box"....
Recipes for Texas Style Smoking are enclosed with it.**



⚠ WARNING ⚠

IMPORTANT SAFETY WARNINGS

READ ALL SAFETY WARNINGS AND INSTRUCTIONS CAREFULLY BEFORE ASSEMBLING AND OPERATING YOUR GRILL

- Use caution when assembling and operating your grill to avoid scrapes or cuts from sharp edges.
- Do not use gasoline, kerosene or alcohol for lighting charcoal. Use of any of these or similar products could cause an explosion possibly leading to severe bodily injury.
- Keep children & pets away from grill. Supervision is necessary and do not leave grill unattended when in use. Use caution when moving grill to prevent strains. Keep grill at least 15 feet from any combustible material (decks, buildings, fences, trees, bushes, etc).
- When adding charcoal and/or wood, use extreme caution.
- Never move grill when it is in use or when it contains hot coals or ashes.
- Do not place grill near flammable liquids, gases or where flammable vapors may be present.
- Use caution since flames can flare-up when fresh air suddenly comes in contact with fire. When opening the lid, keep hands, face and body safe from hot steam and flame flare-ups.
- Do not exceed a temperature of 400 F. Do not allow charcoal and/or wood to rest on the walls of grill. Doing so will greatly reduce the life of the metal and finish of your grill.
- Always wear oven mitts to protect hands from burns. Avoid touching hot surfaces.
- When opening lid, make sure it is pushed all the way back so it rests against the lid support brackets. Use extreme caution as hood could fall back to a closed position and cause bodily injury.
- Close lid and all dampers to help suffocate flame.
- Always hold an open lid from the wooden handle to prevent it from closing unexpectedly.
- Never leave coals and ashes unattended. Before grill can be left unattended, coals and ashes must be removed. Use caution to protect yourself and property. Carefully place remaining coals and ashes in a noncombustible metal container and saturate completely with water. Allow coals and water to remain in metal container 24 hours prior to disposing.
- To protect against bacteria that could cause illness, keep all meats and refrigerated and thaw in refrigerator or microwave; keep raw meats separate from other foods; wash everything that contacts raw meats; cook thoroughly; and refrigerate leftovers immediately. Cook meats medium to well done.

-10-

THESE WARNINGS APPLY ALSO TO THE "SIDE FIRE BOX"



Distribuidor oficial para España:

The Barbecue Store
Avda. Carmen Saenz de Tejada, 1
29650 Mijas Costa (Málaga)
Teléfono: 952477152 - 952477161
Fax.: 952580781
Email: dmbrico2@telefonica.net
http://www.thebarbecuestore.es