

everdure
by heston blumenthal



HUB™

Assembly, operation &
maintenance instructions

for Everdure by Heston
Blumenthal HUB™ electric
ignition charcoal barbeque

everdurebyheston.com



800065



Inspired by the past.
Innovated for the future.

THE OUTDOOR
PERFORMANCE

CONTENTS

Important Safety Instructions	4-6
Appliance Details	7
Operating Instructions	8-9
Ignition Procedure	9
Cleaning & Storage	10
Troubleshooting	11
Barbeque Assembly	12-15
Maintenance	15
Parts List: Barbeque Assembly	16-17
Barbeque Accessories	18

OPERATION AND MAINTENANCE INSTRUCTIONS FOR HBCE2BUS ELECTRIC IGNITION CHARCOAL BARBEQUE RANGE Everdure by Heston Blumenthal outdoor charcoal barbeques. It is important that you retain these instructions, proof of purchase as well as other important documents about this product for future reference. Due to continual product development, Everdure by Heston Blumenthal reserves the right to alter specifications or appearances without notice. Dispose of packaging responsibly – recycle appropriately.

IMPORTANT SAFETY INSTRUCTIONS

IMPORTANT: Read the safety precautions of this booklet carefully before removing the barbeque from its carton or connecting the barbeque to the power supply.

1. This electric ignition charcoal barbeque set is intended for **OUTDOOR USE ONLY**. Do not use indoors. Use the electric ignition barbeque in a well-ventilated area.
2. For your safety and enjoyment, read all operating instructions before using this appliance. Do not use the barbeque unless it's completely assembled and all parts are securely fastened and tightened.
3. In certain circumstances electrical appliances may be a health hazard. Unplug the appliance before cleaning or carrying out maintenance. When the appliance is not in use, unplug the appliance from the electrical outlet and retract the power cord fully.
4. This appliance is not intended for use by persons (including children) with reduced physical, sensory or mental capabilities, or lack of experience and knowledge, unless they have been given supervision or instruction concerning use of the appliance by a person responsible for their safety. Children should be supervised to ensure they do not play with the appliance.
5. Ensure that all electrical connections are secure, dry and protected from moisture before operating this appliance. Do not disconnect the appliance with wet hands and do not disconnect the power cord with extreme force.
6. Always fully extend the retractable power cord when in use (leaving the power cord fully or partially retracted can cause the cord to overheat & become damaged). Take care not to exert undue force on the cord and its assembly when adjusting the length. If use of an extension power lead cannot be avoided, always use good quality (low resistance) leads that are suitable for the environment where cooking is taking place, and use the shortest length possible to reduce any power lost to the appliance.
7. Do not use this appliance with a programmer, timer or any other device that switches the appliance on automatically, since a fire risk exists if the appliance is covered or positioned incorrectly.
8. If the power cord is damaged, it must be replaced by the manufacturer, an authorised service centre or similarly qualified persons to avoid a hazard.
9. Do not immerse the barbeque in water (only removable grills, charcoal grids and rotisserie parts can be immersed).
10. As charcoal can smoulder for an extended period of time, take care when removing ash after cooking. It is recommended that a non-combustible container (metal or ceramic) be used to contain any ash before being doused in water and disposed of correctly.
11. This barbeque has been designed to be used with the four legs connected (do not remove and build in). When using on the ground, ensure the surface is level, and strong enough to support the barbeque and will withstand temperatures of 176°F (80°C) above ambient temperature. The barbeque has to be installed on a secure level base prior to use.
12. People with flammable clothing such as nylon etc. should keep well away from the barbeque when it is operating.
13. Do not use this appliance for any purpose other than what it is intended for.
14. In the event of a oil or grease fire do not attempt to extinguish with water. Immediately call the fire department. A Type BC or ABC fire extinguisher may, in some circumstances contain the fire. Regular cleaning after use should reduce the build-up of fat and food residues which are combustible and can result in a fat fire. **Fat fires can be prevented with diligence in cleaning fats and oil from the heat shield and bowl around the electrical element and the inner chassis.** Do not allow ash to build up inside the chassis – clean up after every use. For more information on controlling fat fires see the Quick User Guide.
15. Ensure that the product has adequate clearance from combustible materials. Do not use within 1ft (250 mm) of any flammable structure or under any combustible surface.
16. Keep your barbeque protected against strong wind where possible (the lid can be used as a rear wind shield by hanging it from the bracket at the rear of the appliance). As charcoal cooking can vary in time and intensity, it is recommended that the barbeque not be left for more than 5 minutes at a time while cooking.
17. We recommend that you regularly maintain your barbeque and keep it in good condition. This can be achieved by following the cleaning and maintenance suggestions in this booklet. Failure to follow these instructions will void your warranty.
18. This appliance is not suitable for mounting in a movable vehicle (boat, trailer etc).
19. Do not use or store this appliance in areas of high salt content (a marine environment) or an area with caustic fumes or liquids (such as a domestic pool), as these chemicals can cause the appliance materials to deteriorate (and void the warranty). Regular cleaning and covering with an Everdure by Heston Blumenthal HUB™ barbeque cover can help to reduce this.
20. Caution: Accessible parts may become hot when used. Whilst the grill handles are cool to touch, please be aware that the grill surface will be hot - handle with care. Do not touch metal parts of barbeque until it has completely cooled to avoid burns, unless you are wearing protective gloves.

21. Burning of solid fuels produces poisonous gases, which can kill! Therefore, never use this appliance indoors or bring indoors if not totally extinguished.
22. Do not use solid fuels impregnated with fire accelerants or use any other type of accelerant on this appliance. This appliance is designed for electrical charcoal ignition only. Using any accelerant could cause serious property damage or personal injury. **WARNING!** Do not use spirit or petrol for lighting or re-lighting! Do not use firelighters for lighting or re-lighting!
23. During ignition, follow the recommended charcoal area placement guide. Once the initial batch of charcoal has ignited, it can be mixed in with fresh charcoal and spread throughout the charcoal chamber. Overloading the charcoal chamber can result in damage to the appliance and food – Its recommended that the charcoal fuel is fully ashed before you commence cooking. The maximum amount of the fuel to be used shall not exceed 1.8 kg. For more information on charcoal placement, see further on in the instruction manual and the Quick User Guide.
24. The ignition timer is set to 7 minutes. Whilst this is in operation, the element will run, heating and igniting the charcoal above it. Once the timer has finished, do not start again as the heat from the element will interfere with the natural progression of the charcoal ashing. Note: If the combined heat from the charcoal and element get too high, an over-temp switch will disable the element (the timer will continue to operate until the 7 minutes have elapsed).
25. Always allow the solid fuel to burn out naturally after cooking. Do not use any liquids to douse the charcoal whilst inside the barbeque. Do not move the appliance while the coals are still burning as hot ash, coal particles, unburned fuel and hot cooking fats & oils could spill and accessible parts may be very hot. The barbeque should not be moved by lifting.
26. Do not use volcanic rock or any type of non-combustible product in the charcoal chamber. If in doubt on what fuels can be used, check the Everdure by Heston Blumenthal website or contact the Service Department.
27. Solid fuels differ widely in burning time, heat, size and combustion. Always be aware of your surroundings and potential fire hazards caused by sparks or spitting fuels. Never dispose of solid fuels or hot ashes in areas where they can be trodden on or be a fire hazard. Never dispose of unburned solid fuels or ash until it has completely extinguished. The barbeque must be installed on a secure level base prior to use. We recommend using 100% natural lump charcoal in this appliance.
28. Always check with your local/state authorities before using this appliance for any fire restrictions regarding the use of an outdoor barbeque (due to local weather

conditions).

29. When using solid fuels, take care that the surrounding environment is clear of combustible materials. Do not cook under overhanging buildings or close branches of trees. Note that solid fuels will produce varying amounts of smoke – take this into consideration when setting up the barbeque.
30. If you have any queries regarding these instructions, contact your local dealer.



Do not cook or store this appliance where liquids can enter the inner section of the appliance (rain, near sprinklers etc.). If the internal section does get wet, unplug the appliance from the electrical socket, allow to cool and move to a protected area. Fully dry out before any further use.



This appliance is not intended for commercial use.



CALIFORNIA PROPOSITION 65 WARNING:

- (a) The burning of gas cooking fuel generates some by products which are on the list of substances known by the State of California to cause cancer, reproductive harm, or other birth defects. To reduce exposure to these substances, always operate this unit according to the use and care manual, ensuring you provide good ventilation when cooking with gas.
- (b) Handling the brass material on this product exposes you to lead, a chemical known to the State of California to cause cancer and birth defects or other reproductive harm. Wash hands after handling.
- (c) This product contains chemicals, including lead and compounds, known by the State of California to cause cancer, reproductive harm, or other birth defects.
- (d) **Wash your hands after using this product.**



DO NOT OPERATE THIS APPLIANCE BEFORE READING THE INSTRUCTION BOOKLET

DO NOT PLACE ARTICLES ON OR AGAINST THIS APPLIANCE

DO NOT STORE CHEMICALS OR FLAMMABLE MATERIALS OR SPRAY AEROSOLS NEAR THIS APPLIANCE

DO NOT OPERATE THIS APPLIANCE INDOORS

DO NOT OPERATE THIS APPLIANCE IN ENCLOSED AREAS

DO NOT USE ACCELERANTS OR FUEL IMPREGNATED WITH ACCELERANTS IN THIS APPLIANCE

DO NOT OVERFILL THE CHARCOAL CHAMBER AT IGNITION

DO NOT ALLOW FATS/OILS, ASH AND UNBURNED FUEL TO BUILD UP IN THE APPLIANCE BETWEEN COOKING SESSIONS

DO NOT ALLOW WATER TO ENTER THE INTERNAL SECTION OF THIS APPLIANCE

APPLIANCE DETAILS

ELECTRICAL:120V AC, 60HZ, 1400W, IPX4

	HUB™		
Barbeque only	LENGTH (ft)	WIDTH (ft)	HEIGHT (ft)
	4.5	1.6	3

	HUB™		
Barbeque only	LENGTH (mm)	WIDTH (mm)	HEIGHT (mm)
	1365	487	900

NOTE: Fully extended, the rotisserie poles increase the height by 6.7in (170 mm)

OPERATING INSTRUCTIONS

GENERAL INSTRUCTIONS

A fairly protected location is desirable for pleasant and efficient cooking. Set up the barbeque in a safe place. Try to keep the barbeque sheltered from strong winds as this will drastically alter cooking efficiency. Keep the barbeque level. Check frequently that the charcoal stays ignited (this does not necessarily mean a flame is visible), and that flare ups are not occurring. Make sure the minimum distances of the barbeque to any wall or combustible surface are met, and that the supporting surface can withstand the heat.

WARNING! This barbeque will become very hot during operation. If you need to move it during operation, we recommend taking extreme care and grab by the handles only. Never grab the barbeque by the body or sides when in use.

For more specific information (including set-up illustrations and diagrams) and up to date cooking instructions, please visit the Everdure by Heston Blumenthal website at www.everdurebyheston.com.

FUEL TYPE AND CONSUMPTION

This barbeque is designed to cook with lump charcoal. The heat produced and consumption time may vary dramatically depending on the type of fuel used, and the prevailing weather conditions. Please see the Quick User Guide for more information on charcoal ignition and cooking. Do not use accelerants for fuel ignition or fuels impregnated with accelerants in this appliance as they may cause damage to the appliance or injury.

Place enough charcoal into the fuel compartment according to the instruction manual. Light the charcoal using the Fast Flame Ignition System™. The charcoal will then burn for a period with flames. When burning is established, spread the fuel evenly. Make sure that the cooking grid is fully located into the grill supports, then you can enjoy your barbequing. Do not cook before the fuel has a coating of ash.

After cooking, the remaining charcoal should be allowed to burn off naturally (this should be taken into account when planning the cooking times). Once finished, the ash and remaining fuel should be removed and placed into a non-flammable container (a metal bucket is ideal), a small amount of water added (just in case there is still any heat left in the waste) and disposed of safely as per local council rules. Note that protection from heat should always be used.

CHROME OPEN GRILL

The cooking surface for this barbeque is a pair of chromed open grills, which can be fully removed or levered up from the front to add additional charcoal. The grills should be positioned so that the grill handles are to the front (they will allocate in the notches at the front of the barbeque). Take care that food cooked is wider than the gaps in the grills or positioned lengthways so it doesn't fall through. Over time, the surface of the grills will discolour with the heat of the fuel (this is a normal process and not a fault). It is recommended that the grills are placed on the barbeque after the charcoal has ignited and any adjustment on the fuel distribution has been done. If needed please remove the grills for greater clearance. After use, allow the grills to cool and then clean. After cleaning, coat with a little cooking oil to minimise any rusting. Note - During and after operation: Whilst the grill handles are cool to touch, please be aware that the grill surface will be hot - handle with care.

ROTISCOPE TECHNOLOGY™

Rotiscope Technology™ is the patent pending built-in rotisserie system of the barbeque. The maximum rated capacity of the motor is 88lbs (40 kg). Please check the dimensions of the meat are suitable for the product before purchasing.

The rotisserie rod and Cliplock Forks™ are stored in the compartment at the front of the left hand side panel. Lift the storage door up, remove the Cliplock Forks™ (take care of the sharp points of the fork fingers) and pull the rod out from the storage compartment (this is enclosed so the rod will not interfere with the electrical wiring). Note: If the barbeque has been in operation, the rotisserie parts may be hot – remove before cooking or use heat proof gloves. To fit food onto the rotisserie, first slide a Cliplock Fork™ (base first) onto the rod, and lock off by pressing down the small fork lever. Push the food onto the rotisserie rod and onto the Cliplock Fork™. Push the second Cliplock Fork™ onto the rod and into the other end of the food, and lock in position by pressing down the small fork lever. This can be repeated (if necessary) with the second set of Cliplock Forks™.

To extend the rotisserie poles, first press and release them so the inner section pops out from the barbeque. Pull the poles up and rotate clockwise to allocate the poles in one of the 3 height settings. The pole to the right contains the rotisserie motor. Take the rotisserie rod with the food attached and place the pointed end in the motor hole at the top of the right hand side pole. Lever the handle side of the rod down into the slot of the left hand pole and close the pole cover. Turn on the rotisserie by pressing the right button (an

audible sound and LED will indicate this has turned on). Adjust charcoal to suit the food being cooked.

Do not leave the appliance cooking for extended periods of time unattended. As food cooks on the rotisserie, fat can drip off causing flare-ups which can spoil food. Constant supervision can help to reduce the incidence of food spoilage.

When the food has finished cooking, press the right button again (the LED at the switch will turn off), to stop the rotisserie from turning. Hold the handle with one hand and lift the other end from the motor (using heat resistant gloves). Place food on a platter and release the outer Cliplock Fork™, then remove using metal tools. Release the second Cliplock Fork™ and remove the rod. Pull the second fork from the food. Note: Take care as the rotisserie parts will be hot. Clean the rod by rubbing down with water and detergent, and clean the Cliplock Forks™ by first soaking in hot water and then rubbing down with water and detergent. Once dry, the rod can be coated with a thin film of cooking oil.

With the barbeque cool, open the storage door on the left hand side of the barbeque and push the rod into the round hole, then overlap the Cliplock Forks™ and put next to the rod handle. Rotate the two rotisserie poles anti-clockwise and then lower. To fix into the barbeque, press them slightly below the top level of the barbeque and release (the internal spring switch will then hold them in place).

AFTER COOKING

1. After cooking and whilst the barbeque is still warm, remove scraps from the grill with a scraper.
2. Excess fat and meat scraps can be scraped off the inside of the barbeque by removing the grill to gain access. **WARNING:** Some surfaces may still be hot – please use protective gloves.
3. Remove wastes from inside charcoal chamber, and under the charcoal grid and element.
4. To clean your barbeque, soak the cooking grill and tools in hot soapy water as soon as possible after use. Dry thoroughly and store in a dry place.
5. Protect the barbeque with a cover or store inside. Do not leave your barbeque outside unprotected.

IGNITION PROCEDURE



READ ALL OPERATING INSTRUCTIONS BEFORE IGNITING THE CHARCOAL.
TAKE CARE, THE POWER CORD CANNOT TOUCH ANY HOT SURFACES OR IGNITED CHARCOAL

LIGHTING THE BARBEQUE USING THE FAST FLAME IGNITION SYSTEM™

The Fast Flame Ignition System™ works on the principle that charcoal will ignite when heated above a certain temperature (it is not dependant on a flame to ignite). First pile the charcoal over the charcoal grid (allowing it to overflow up to 0.8in (20 mm)). With the charcoal in place, press the left button (an audible sound and LED will indicate that the element has turned on). The element will heat up and run for 7 minutes. During this time, the charcoal closest to the element will ignite. As it heats up and ashes, the surrounding charcoal will do the same. After 7 minutes the element will turn off and the ignition of the charcoal will continue to naturally ignite. After 10-15 minutes (depending on the weather conditions and the fuel used), most of the charcoal should have partially or fully ignited. Using metal tools, spread the charcoal inside the charcoal chamber and add extra fuel if necessary (extra fuel can be added during the cooking period as well). Never use more than 1.8 kg of fuel at any one time. See the Quick User Guide for more information.

CLEANING & STORAGE

EXTERNAL CLEANING

Before cleaning the barbeque exterior, ensure the appliance has cooled and is safe to touch, and that the appliance has been removed from the power supply. Painted and plastic surfaces can be cleaned using a mild household detergent or cleaner and a clean cloth (do not use scourers or harsh detergents). **It is advisable to test cleaners on a small section of the appliance first. NEVER** use paint thinners or similar solvents for cleaning and **NEVER** pour cold water over hot surfaces. Dry the surface afterwards. Top panel covers should be removed and the area underneath cleaned. Rotisserie poles should be wiped down with a soft cloth to remove any oil or grit (do not allow water to flow down the poles and into the barbeque).

INTERNAL CLEANING

Before cleaning the internal parts of your barbeque, ensure the appliance has cooled and is safe to touch. The inside of the charcoal chamber can be cleaned by using some water, mild detergent and a sponge or mild scouring pad.

For hard to clean areas, use a little baking soda on a wet sponge. Do not use abrasive cleaners. All ash and any leftover fuel should be removed after every use (take care that it is fully extinguished and cold). After cleaning the charcoal chamber, remove the charcoal grid and carefully twist the element upwards. Remove the element bracket (X) and remove and empty the heat shield. Clean any ash or oil that may have dropped into the element bowl, and replace the heat shield and element bracket. Twist the element back over the bracket and replace the charcoal grid. Note: all parts **MUST** be in place correctly before cooking again.

WARNING! The surfaces of the open grills may be hot. Please ensure heat resistant gloves are worn.

STORAGE

When the appliance is not in use, the barbeque can be stored outdoors, but must be under cover and covered (preferably with a purpose made HUB™ Barbeque cover), out of the weather. Ensure the cooking surface is clean before storing away. Do not leave the power cord connected to the power supply for extended periods of time (disconnect after use).

TROUBLESHOOTING

Solid fuel is not igniting or taking longer than expected to ignite:

Power supply interrupted	Check the LED at the ignition switch is lighting when pressed. Check cord is connected & turned on. Check power is being supplied to appliance (power outage or tripped circuit breaker). Check that retractable power cord has not been pulled out too far (it can interrupt the internal power connection).
Poor type of solid fuel used	Fuel may be wrong size (parts too large). Break up larger parts so they can ignite easier. Purchase a different type of charcoal and try. We recommend using 100% natural lump charcoal in this appliance (see www.everdurebyheston.com).
Solid fuel is damp	Solid fuels can become damp over time, which retards ignition. Store in a dryer place & re-purchase fresh solid fuel.
Solid fuel incorrectly distributed in charcoal chamber	Follow the instructions on placing the solid fuel in the charcoal chamber. If charcoal has compacted down tight, remove some solid fuel so air can flow freely through and assist in ignition. If too little fuel is used, the heat and ignition may not pass as fast between separate pieces.
Timer or element not working	Remove fuel and check LED on ignition switch is lighting up when pressed. Check for heat from the element (without fuel this should run for 7 minutes before turning off) with a hand at a safe distance. If not running, contact your nearest Service Centre.
Internal components not aligned correctly	Check element heat shield, support bracket and element are correctly positioned. Check charcoal chamber is correctly allocated in lower tabs. Check charcoal grid is correctly allocated in charcoal chamber.
Barbeque not cleaned	Check ash has not collected inside the element bowl or heatshield, or blocked the charcoal grid
Weather conditions & ambient temperature	Cold, windy and wet conditions will affect the ignition and combustion process. Move barbeque to a more suitable location.

Rotisserie system not working:











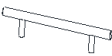

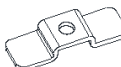

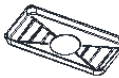
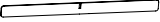

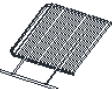
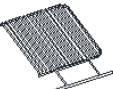
Power supply interrupted	Check the LED at the rotisserie switch is lighting when pressed. Check cord is connected & turned on. Check power is being supplied to appliance (power outage or tripped circuit breaker). Check that retractable power cord has not been pulled out too far (it can interrupt the internal power connection).
Rotisserie rod not seated in motor correctly	Remove rod from poles and check motor socket is rotating. Place rod in motor and check handle end is correctly allocated in the slot of the left hand pole.
Rotisserie overloaded	Check rod rotates without food, and then with food. Remove some of the food from the rotisserie and try again.
Rotisserie motor has jammed	Motor or internal parts have seized. Contact your nearest Service Centre..

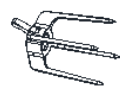
BARBEQUE ASSEMBLY

The barbeque must be fully assembled before use. Only a medium size Philips screwdriver and an adjustable spanner are needed.

Open the carton and remove the parts (Note that the barbeque chassis assembly is heavy and will require at least 2 people to move). Remove all packaging (especially check inside the barbeque and under the charcoal grid) and place parts on a clean surface. Check for any damage or missing parts (if found, contact your service department).

INCLUDED PARTS HUB™

01/ Barbeque Chassis Assembly x 1Pc	02 / Lid Handle x 1Pc	03 / Lid x 1Pc	04 / Lid Hanging Bracket x 2Pcs	05 / Top Panel Cover x 2Pcs	06 / Charcoal Grid x 1Pc	07 / Charcoal Chamber x 1Pc	08 / Element Support x 2Pcs
							
09 / Element Heat Shield x 1Pc	10 / Left Hand Open Grill x 1Pc	11 / Right Hand Open Grill x 1Pc	12 / Rotisserie Rod x 1Pc	13 / Cliplock Fork™ x 4Pcs	14 / Leg Left Front x 1Pc	15 / Leg Left Rear x 1Pc	16 / Leg Right Front x 1Pc
							
17 / Leg Right Rear x 1Pc	F01 / M4x0.4in (10mm) x 2Pcs	F02 / Hex Bolt M6 x0.5in (12mm) x 16Pcs	F03 / Spring Washer Ø0.2in (4mm) x 2Pcs	F04 / Washer Ø0.2in (4mm) x 2Pcs			
							

PACKAGING

Remove all internal cartons and packaging from within the barbeque assembly. Remove all external packaging and remove the appliance from the packaging base before operation. Recycle as per your local government/state laws.

STEP 01

/ Take the $\varnothing 4\text{mm}$ spring washers (F03) and $\varnothing 0.2\text{in}$ (4mm) washers (F04) and place them onto two M4x0.4in (10mm) screws (F01). Take the two lid hanging brackets (04) and fit onto the two M4x0.4in (10mm) screws (the legs of the brackets should hang around the screw heads). Place the handle (02) on the inset side of the lid (03) and align the handle legs with the two holes. Fix the lid hanging brackets to the bottom of the lid by screwing the screws into the handle legs (take care that the hanging brackets are running parallel to the lid shorter sides). Tighten fully. If assembled correctly, the lid will hang from the bracket at the rear of the barbecue using the lid hanging brackets to hook it in place.

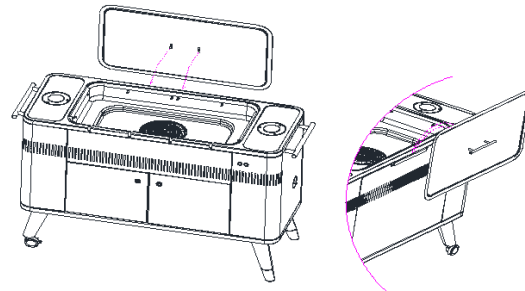
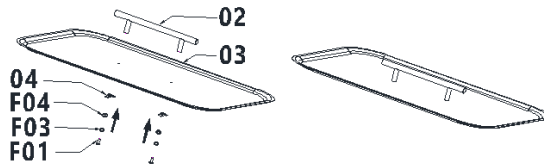

STEP 02

/ Rotate the barbecue chassis assembly (01) onto its rear panel and lay on a clean flat surface (the cardboard packaging is ideal). Fix the four legs (14, 15, 16 & 17) to the bottom panel (castors to the left hand side) using sixteen M6 bolts (F02). Note that when finished, the legs will angle out towards the corners.

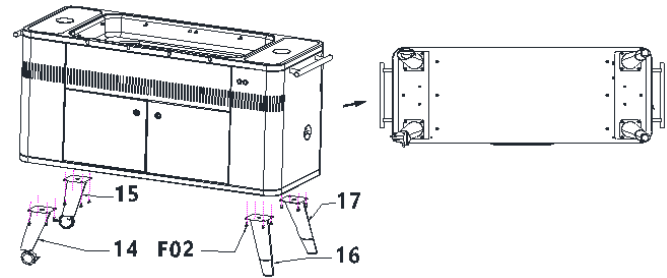

STEP 03

/ Take the two Top Panel Covers (05) and place them over the end of the rotisserie poles at either end of the barbecue. Press into place.

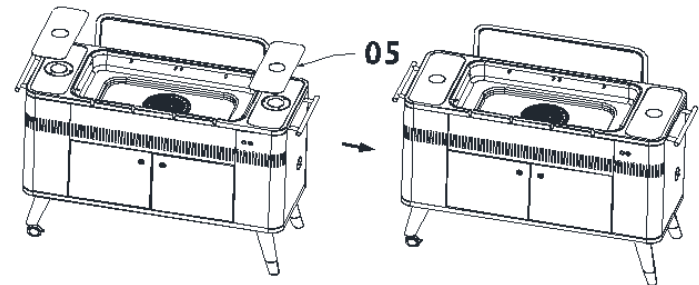

STEP 04

/If not already assembled, lever up the element and place the heat shield (09) inside the bowl. Take the two element supports (08), fit them together and place them centrally on the heat shield. Lever the element back down onto the element supports.*

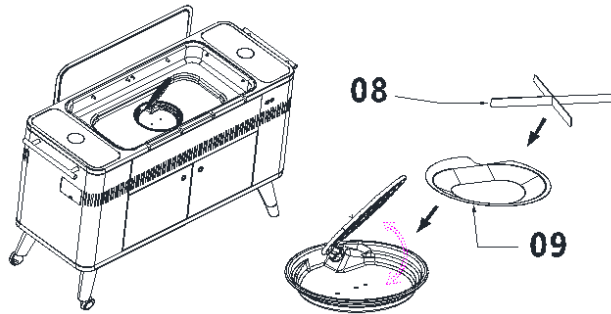

STEP 05

/Place the charcoal chamber (07) centrally within the barbecue and place the charcoal grid (06) in the centre hole above the element.

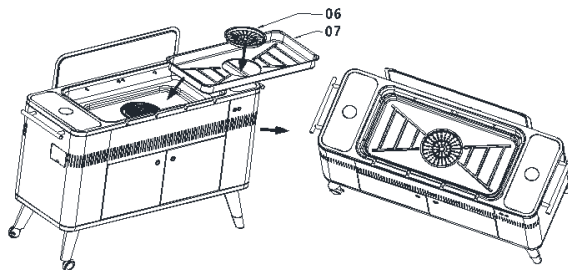

STEP 06

/Place the left hand open grill (10) and right hand open grill (11) on the twelve pins on the inner chassis (above the charcoal chamber) and lever down into the notches at the front of the barbecue. Take care that the grills are level and stable.

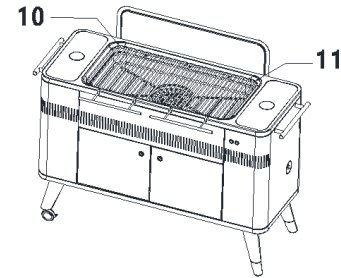

STEP 07

/The rotisserie rod and Cliplock Forks™ are stored in the compartment at the front of the left hand side panel. Lift the storage door up, remove the Cliplock Forks™ (13) (take care of the sharp points of the fork fingers) and pull the rotisserie rod (12) out from the storage compartment. Note: If the barbecue has been in operation, the rotisserie parts may be hot – remove before cooking or use heat proof gloves. The Cliplock Forks™ slide on the rod and are locked in place by pressing down on the fork levers.

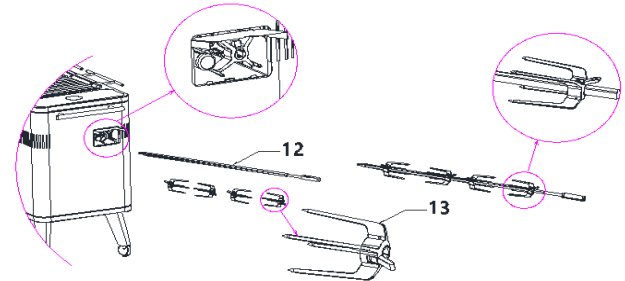

STEP 08

/To extend the rotisserie poles, first press and release them so the first section pops out from the barbecue. Pull the poles up and rotate clockwise to allocate the poles in one of the 3 height settings. The pole to the right contains the rotisserie motor.

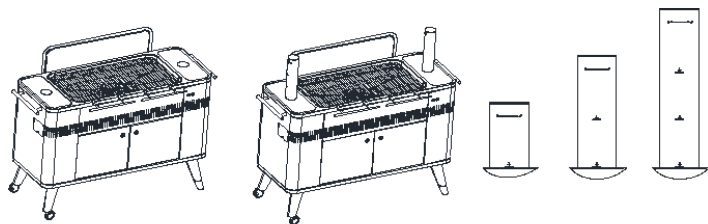

STEP 09

/Take the rotisserie rod with the food attached and place the pointed end in the motor hole at the top of the right hand side pole. Lever the handle side of the rod down into the slot of the left hand and close the pole cover.

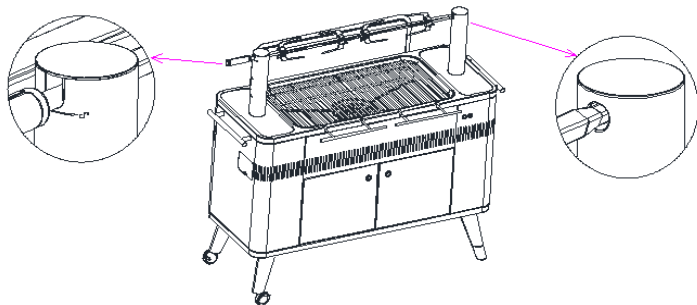

STEP 10

/With the barbecue in a secure position, fully extend the power cord from the recess on the right hand side (do not over-extend) and connect to your power supply.

*Due to ongoing design modifications, support brackets may be permanently fixed to the element

MAINTENANCE

It is recommended that at the commencement of each barbecue season the following maintenance be conducted:

BARBEQUE

1. Wipe over the outer areas of the barbecue with a clean cloth.
2. Check all oils and ash have been cleaned from the charcoal chamber and under the element.
3. Check all fasteners for tightness and re-tighten where necessary to ensure rigidity of the structure.
4. Check retractable power cord is operational and the cord/plug is undamaged.

Wear and tear to this barbecue can be reduced by covering and storing out of the weather when not in use.

PARTS LIST: HBCE2BUS

	PART NAME	QTY
1	Foot Front	1
2	Hex Bolt M6x0.5in (12mm)	16
3	Leg Upper Right Front	1
4	Foot Rear	1
5	Leg Upper Right Rear	1
6	Chassis Right Hand Side Panel	1
7	Pole Assembly Support	2
8	Hex Bolt M8x0.4in (10mm)	4
9	Plug Recess	1
10	Plug recess Bracket	1
11	Retractable Power Cord Assembly	1
12	Power Cord Assembly Cover	1
13	Chassis Rear Panel	1
14	Chassis Top Plate Assembly	1
15	Element Spring	1
16	Grill Support Long	4
17	Inner Pole Assembly Right	1
18	Inner Chassis	1
19	Pole Flange	2
20	Right Open Grill	1
21	Lid	1

22	Rotisserie Fork	4
23	Rotisserie Rod	1
24	Lid Handle	1
25	Inner Pole Assembly Left	1
26	Left Open Grill	1
27	Outer Pole Assembly	2
28	Charcoal Grid	1
29	Charcoal Chamber	1
30	Element Assembly	1
31	Top Panel Covers	2
32	Element Support	2
33	Storage Door	1
34	Element Heat Shield	1
35	Grill Support Short	8
36	Element Bowl	1
37	Barbeque Handle	2
38	Chassis Left Hand Side Panel	1
39	Element Bowl Support	1
40	Fork & Rod Storage Box	1
41	Door Magnet	2
42	Chassis Front Panel	1
43	Chassis Bottom Panel	1
44	Castor Leg Rear	1
45	Thermostat Mount	1

46	Thermostat	1
47	Castor Leg Front	1
48	Cabinet Top Panel	1
49	Cabinet Side Panel	2
50	Cabinet Shelf	1
51	Door Inner Panel	2
52	Door Upper Hinge	2
53	Left Hand Door	1
54	Right Hand Door	1
55	Door Handle	2
56	Door Lower Hinge	2
57	Lockable Castor	2
58	PCB Top Cover	1
59	PCB	1
60	PCB Bottom Cover	1
61	PCB Mounting	1
62	Element Switch	1
63	Rotisserie Motor Switch	1

Note: List does not include all fasteners.

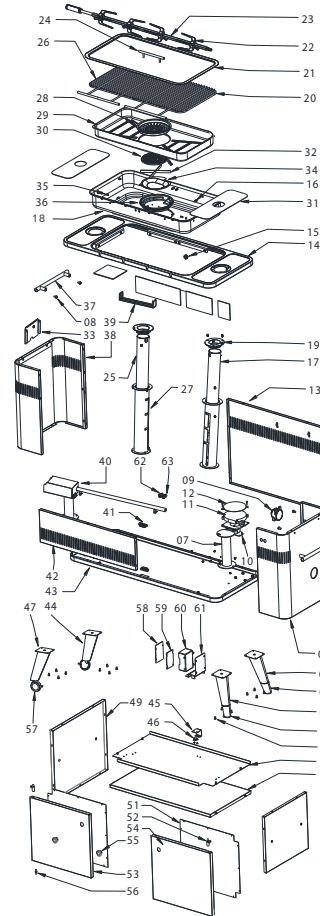

OPTIONAL ACCESSORY: COOKING ACCESSORIES

Please see www.everdurebyheston.com for a full range of accessories



everdure

by heston blumenthal



Distribuidor oficial para España:

The Barbecue Store

Avda. Carmen Saenz de Tejada, 1

29650 Mijas Costa (Málaga)

Teléfono: 952477152 - 952477161

Fax.: 952580781

Email: dmblico2@telefonica.net

<http://www.thebarbecuestore.es>

everdurebyheston.com