

# MANUAL

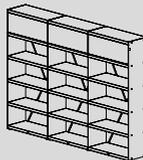

## OFYR® MANUAL WOOD STORAGE 100, 200, 300 AND WOOD STORAGE INSERT

THANK YOU SO MUCH FOR BUYING AN OFYR® PRODUCT. THIS MANUAL CONTAINS SETUP INSTRUCTIONS, WARRANTY CONDITIONS, AND ADDITIONAL INFORMATION ABOUT YOUR WOOD STORAGE 100, 200, 300 AND WOOD STORAGE INSERT.

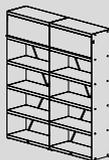
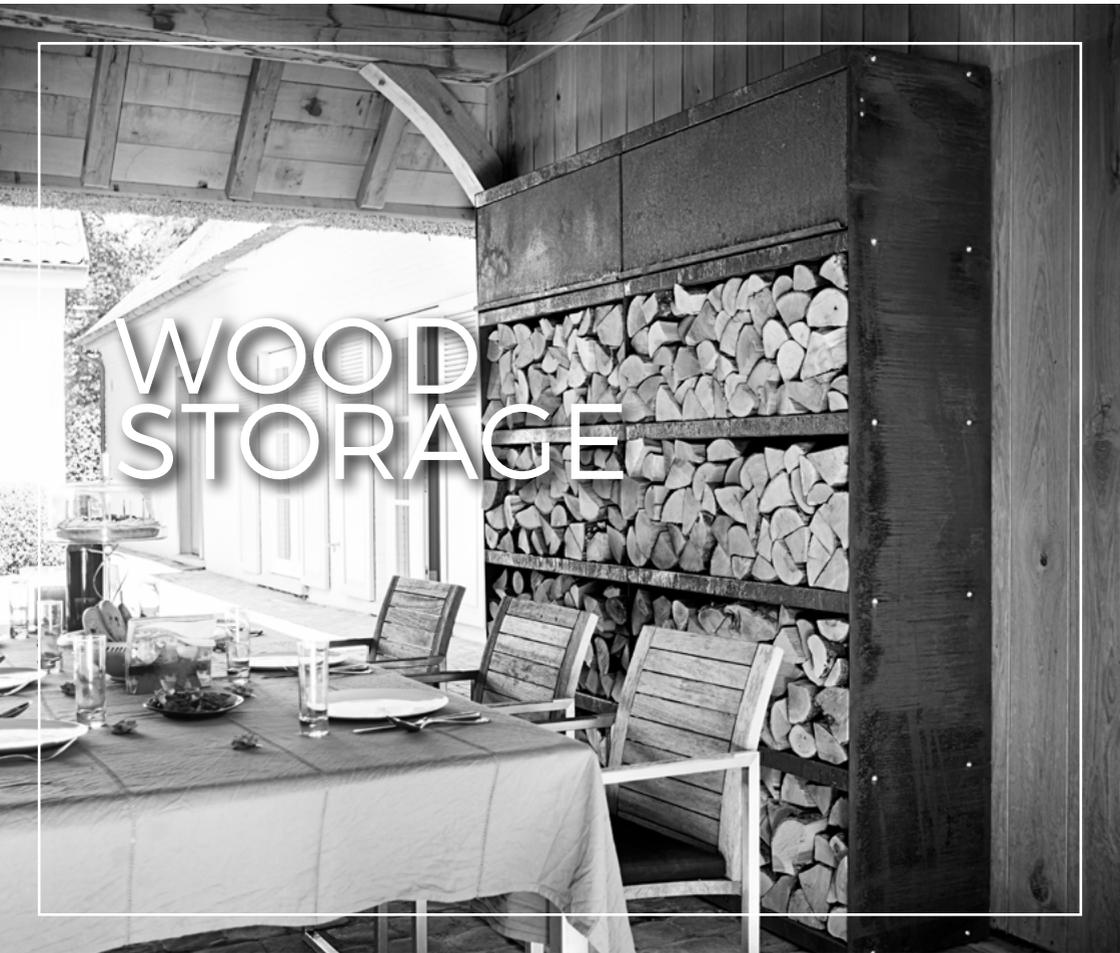
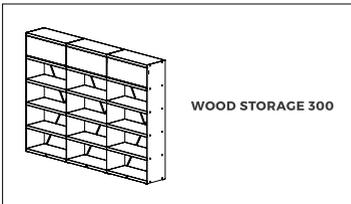
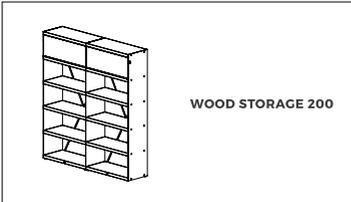
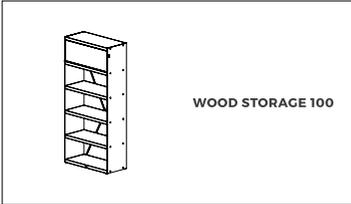

### WOOD STORAGE 100, 200, 300

The Wood Storages are very heavy and must be attached to a solid wall via the holes in the backs of the boards. If they fall over, this may cause severe or life-threatening entrapment injuries. The lids are equipped with sets of two hinges. Corrosion may develop on these hinges due to exterior influences. Wood Storages should not be placed in open spaces without being attached to a wall. We are not liable for any injury resulting from incorrect use of our Wood Storages. The mounting hardware to mount your Wood Storage on the wall is not included, because different types of walls require different mounting hardware. Use mounting hardware that is suitable for your wall type. Please contact a specialised dealer to obtain advice regarding which hardware to use. If the surface is not entirely level, you can use the adjustable feet to adjust the Wood Storage's position until it is level. Please note that if the adjustable feet are extended too far, Wood Storages may become unstable. We recommend a maximum difference in level of 10mm. If the level difference exceeds 10mm, we recommend levelling the surface before setting up your Wood Storage. Once the Wood Storage has been set up, it must not be shifted. Shifting it could cause damage to the adjustable feet or the rivet nuts with which the adjustable feet are attached. We do not accept warranty claims or liability for any damage resulting from shifting Wood Storages.

### WOOD STORAGE INSERT

The Wood Storage Insert is ideal for growing cooking herbs and adds a splash of green to the woodpile. Made from steel with drilled drainage holes, it has a narrow 22cm depth so logs can be stored behind.

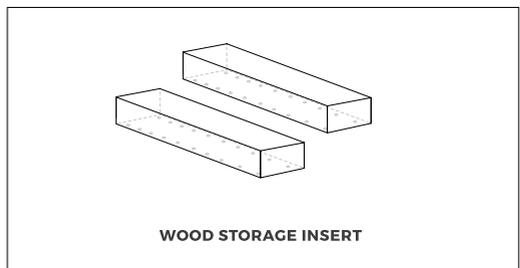

## Disclaimers

### WARNING

Serious or fatal crushing injuries can occur from furniture fall over. To prevent this furniture from falling over it must be permanently fixed to the wall. Fixing devices for the wall are not included since different wall materials require different types of fixing devices. Use fixing devices suitable for the walls. For advice on suitable fixing systems, contact your local specialized dealer. Please note that you should never leave your OFYR® Wood Storage unattended and keep children and pets away from the Wood Storage as well.

### CORROSION

With the exception of the cooking plates, adjustable feet, hinges, screws, and the magnets underneath the wooden planks, all steel elements of the OFYR® collection are made of weathered steel. Weathered steel is a type of steel that corrodes very rapidly, and it is precisely this corrosion that protects it against rust perforation. If you allow nature to take its course, it will take 6-12 months for these weathered steel elements to corrode, depending on their location and the humidity level. Unlike many manufacturers of weathered steel products, we provide buyers of our products with an additional service by making sure that the corrosion process has already started by the time our products are delivered. Depending on their location and the humidity level, it will take another 3-6 months for this superficial corrosion to turn into a proper layer of corrosion. However, this does not guarantee an entirely smooth layer of corrosion. Therefore, any weathered steel elements that are less corroded than others upon delivery are not eligible for replacement. After all, they will corrode naturally over time under influence of the weather. While the corrosion is still superficial, the weathered steel elements may cause orange stains on clothes, skin, and the surface they stand on. When it rains, corrosive water may also run off these elements, which may permanently stain light-toned stone or wooden surfaces. Under normal circumstances, the weathered steel will gradually develop a smooth, dark brown layer of corrosion that will not chip. However, this layer may chip in locations near the sea or the shore due to the high levels of salinity in such locations. The chipping will not cause any damage, but the chipped corrosion must be removed to prevent corrosion from forming on the surface the OFYR® unit is placed on.

### ADJUSTABLE FEET

Once the Wood Storage has been set up, the adjustable feet can be used to make them level. We do not recommend using these feet to adjust the overall height of our Wood Storage, because they may become unstable if the adjustable feet are extended by more than 10mm. We do not accept liability for any damage resulting from improper use of adjustable feet. Once the Wood Storages have been set up, they must not be shifted. Shifting them could cause damage to the adjustable feet or the rivet nuts with which the feet are attached. We do not accept warranty claims or liability for any damage resulting from shifting and/or moving the OFYR® Wood Storages.

## Warranty terms per element

A limited lifetime warranty applies to the material and construction of all steel elements of all OFYR® cooking units for the original buyers or owners, provided that they purchased their unit from an authorised dealer and registered their warranty in the required manner.

	B2C	B2B
WOOD STORAGE & WOOD STORAGE INSERT	2 YEARS	1 YEAR

# Several boxes

Wood storage

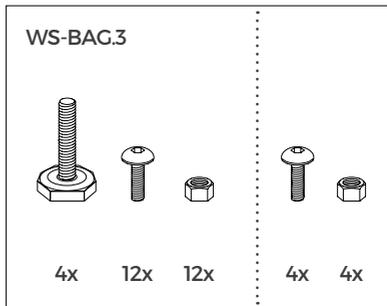
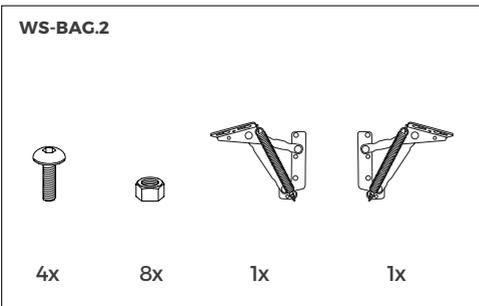
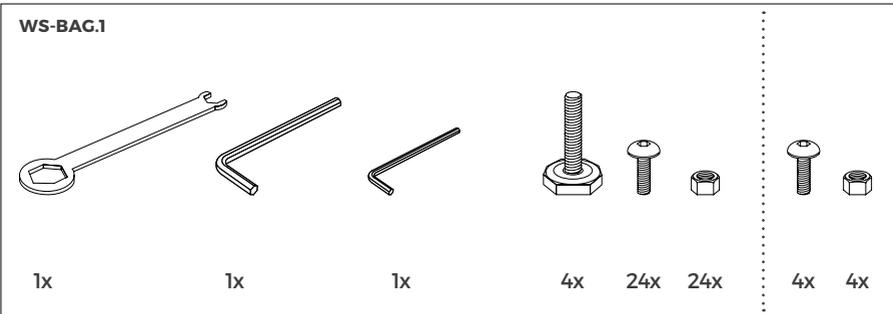
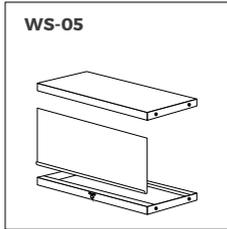
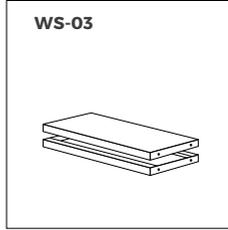
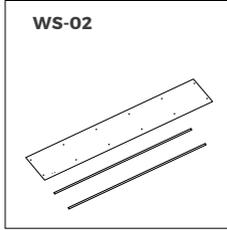
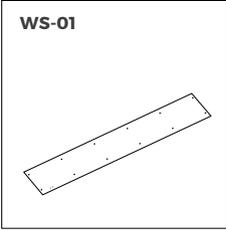

## Dimensions

Wood storage

### WS-100

WS-01	1x	WS-04	1x
WS-02	1x	WS-BAG.1	1x
WS-03	2x	WS-BAG.2	1x

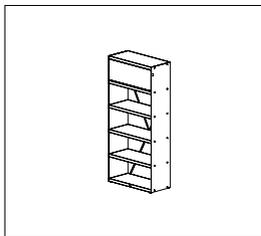

<b>Dimensions</b>	Height	216 cm
	Width	100 cm
	Depth	45 cm
<b>Compartment space</b>	Height	37 cm

<b>Material</b>	Corten steel
<b>Total weight</b>	± 109 kg
<b>Storage</b>	± 1 m <sup>3</sup> wood

### WS-200

WS-01	1x	WS-05	1x
WS-02	2x	WS-BAG.1	1x
WS-03	4x	WS-BAG.2	2x
WS-04	1x	WS-BAG.3	1x

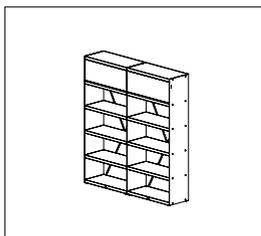

<b>Dimensions</b>	Height	216 cm
	Width	200 cm
	Depth	45 cm
<b>Compartment space</b>	Height	37 cm

<b>Material</b>	Corten steel
<b>Total weight</b>	± 173,6 kg
<b>Storage</b>	± 2 m <sup>3</sup> wood

### WS-300

WS-01	1x	WS-05	2x
WS-02	3x	WS-BAG.1	1x
WS-03	6x	WS-BAG.2	3x
WS-04	1x	WS-BAG.3	2x

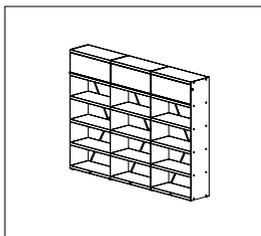

<b>Dimensions</b>	Height	216 cm
	Width	300 cm
	Depth	45 cm
<b>Compartment space</b>	Height	37 cm

<b>Material</b>	Corten steel
<b>Total weight</b>	± 249,7 kg
<b>Storage</b>	± 3 m <sup>3</sup> wood

# Building instructions

Wood storage 100

WS-04 bottom

WS-04 top

WS-01 sidewall



01

WS-02 sidewall



02

WS-03 shelves



03

WS-03 shelves

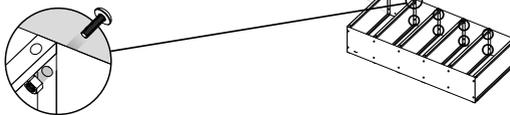

04

WS-02 stabilizing metal rods

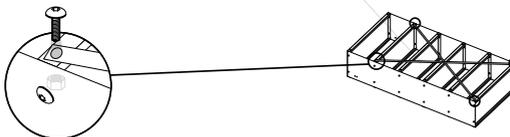

05

WS-BAG.1 & WS-BAG.3 FEET

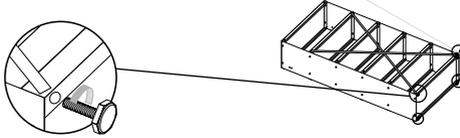

06

WS-BAG.2

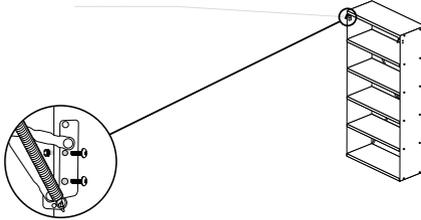

07

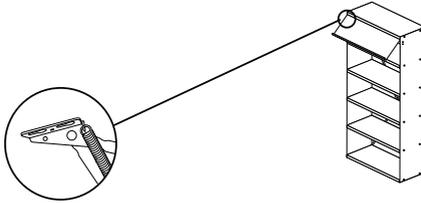

08



09

# Building instructions

Wood storage 200

WS-04 bottom

WS-04 top

WS-01 sidewall

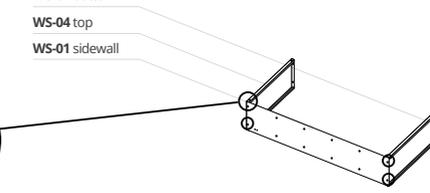
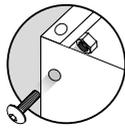

01

WS-05 bottom

WS-05 top

WS-02 sidewall

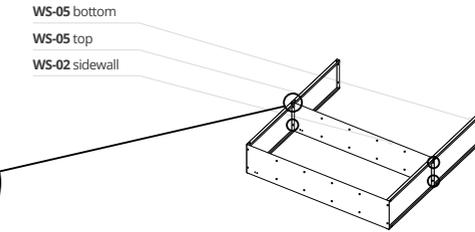
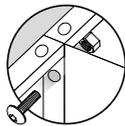

02

WS-05 bottom

WS-05 top

WS-02 sidewall

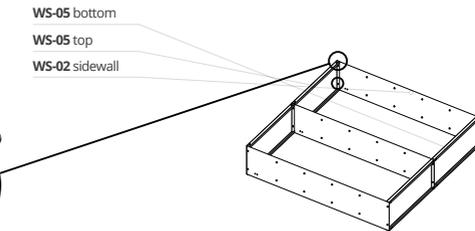

03

WS-03 shelves

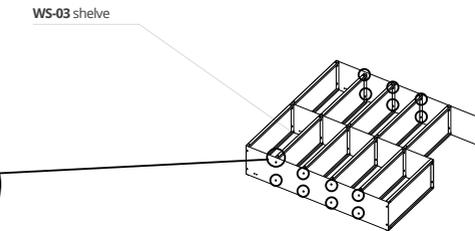

04

WS-03 shelves

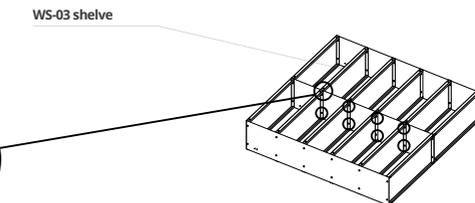
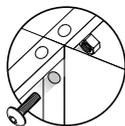

05

WS-02 stabilizing metal rods

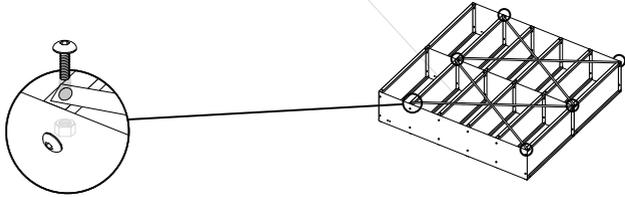

06

WS-BAG.1 & WS-BAG.3 feet

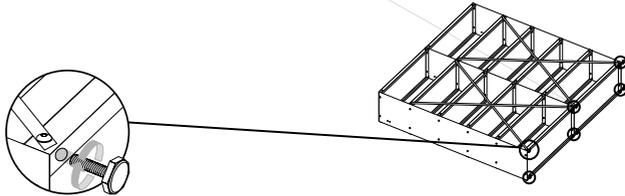

07

WS-BAG.2



08

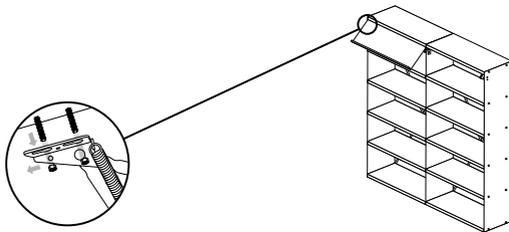

09

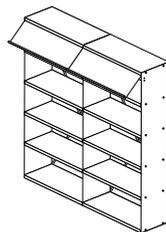

10

# Building instructions

Wood storage 300

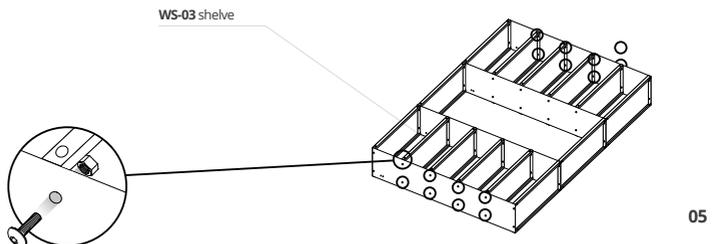
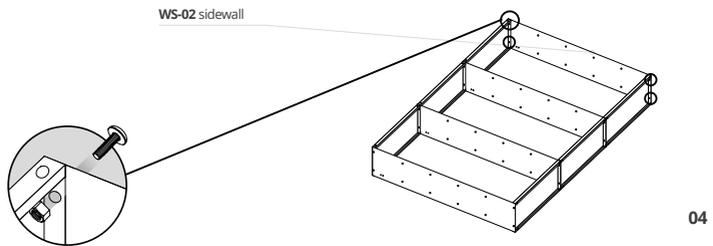
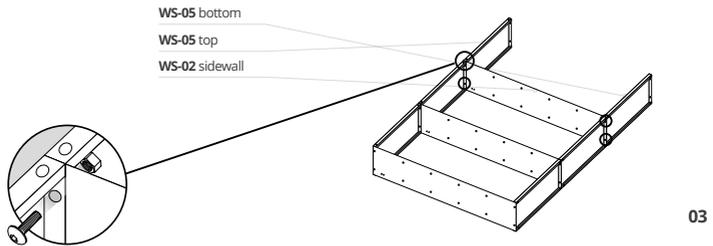
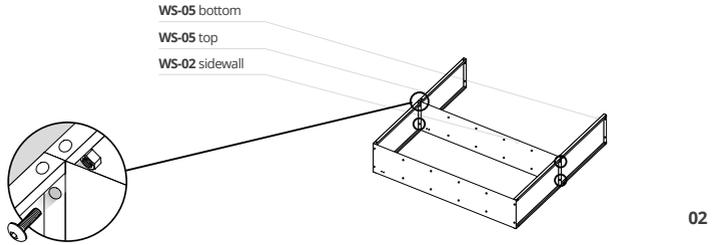
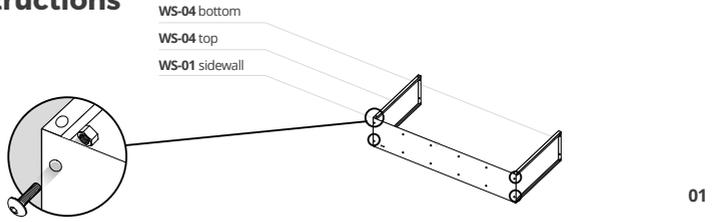

06

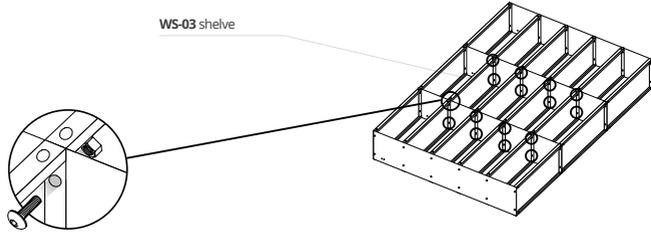

07

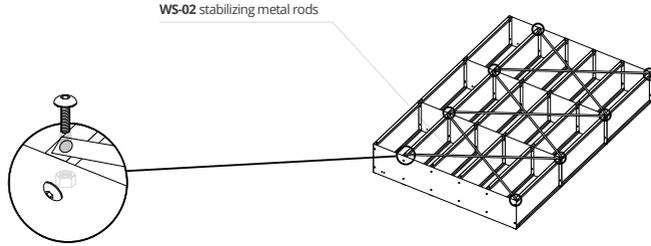

08

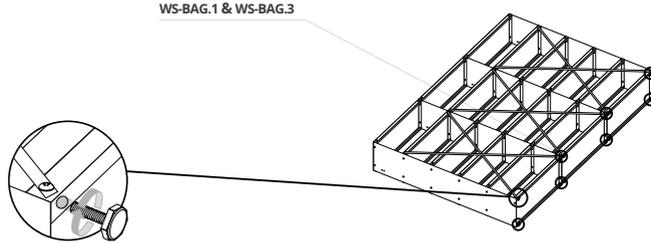

09

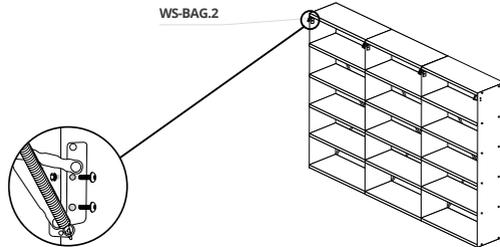

10

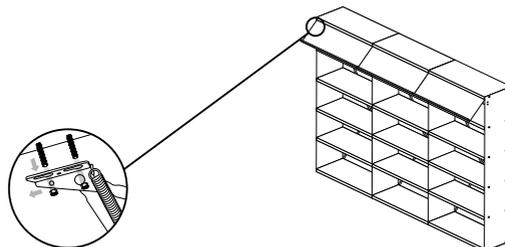

For further information,  
please contact one of  
our official distributors.

**Copyright OFYR.**

All rights reserved.

**Creative Outdoor Products B.V.**

Gewenten 43A  
4704 RE Roosendaal  
Nederland

+31 (0)165 74 31 10  
info@ofyr.com  
www.ofyr.com

The design of some OFYR products have EU registration  
under no 002580431-0001/2 and no 003122373-0001.  
A US Design patent is registered under no US D798,099 S.

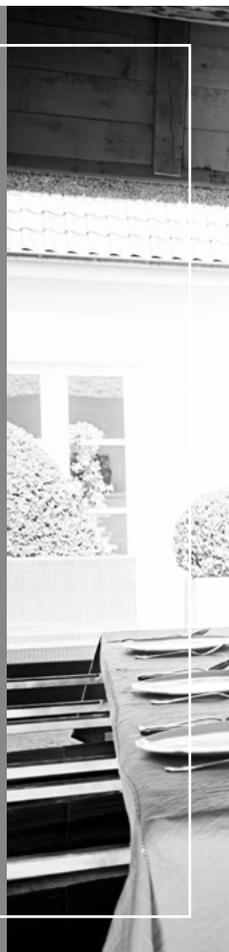

**Distribuidor oficial para España:**

**The Barbecue Store**  
**Avda. Carmen Saenz de Tejada, 1**  
**29650 Mijas Costa (Málaga)**  
**Teléfono: 952477152 - 952477161**  
**Fax.: 952580781**  
**Email: [dmbrico2@telefonica.net](mailto:dmbrico2@telefonica.net)**  
**<http://www.thebarbecuestore.es>**

  
**OFYR**<sup>®</sup>  
THE ART OF OUTDOOR COOKING

NOVEMBER 2017 - V01